

The CLA family of printed circuit board terminal blocks are molded in sizes ranging from 2 to 24 positions. The CLA block is rated at 14 Amps, 300 volts and can handle a wire range of 30-12 AWG. They are also available in a right angle pin version. The standard color of the CLA terminal block is green, however they are available in other colors upon request.

SPECIFICATIONS

Housing Material -	PA68 Polyamide, Flammable UL94V0
Housing Color -	Green
Screw -	Zinc Plated Steel
Clamp -	Nickel Plated Brass
Pin -	Tin Plated Brass
Testing torque -	4.4 in/lb
Wire range -	30-12 AWG
P.C.B mounting hole -	1.5mm
Nominal current -	14 A
Voltage -	300 V
Temperature -	85° C

Part #	No. Positions
CLA5.08-2VE	2
CLA5.08-3VE	3
CLA5.08-4VE	4
CLA5.08-5VE	5
CLA5.08-6VE	6
CLA5.08-7VE	7
CLA5.08-8VE	8
CLA5.08-9VE	9
CLA5.08-10VE	10
CLA5.08-11VE	11
CLA5.08-12VE	12
CLA5.08-13VE	13
CLA5.08-14VE	14
CLA5.08-15VE	15
CLA5.08-16VE	16
CLA5.08-17VE	17
CLA5.08-18VE	18
CLA5.08-19VE	19
CLA5.08-20VE	20
CLA5.08-21VE	21
CLA5.08-22VE	22
CLA5.08-23VE	23
CLA5.08-24VE	24

CLA

Blocco unico
Monobloc

Single block
Einzelblock



Poli
Póles

Poles
Polzahl

2/24

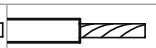

5	5,08
250	
24	

		
0,2 ÷ 4 30 ÷ 12	0,2 ÷ 2,5 30 ÷ 12	0,2 ÷ 2,5 30 ÷ 12
6		
0,5	/	4
110		
PA - UL 94 V0		
M3		
	0,6 x 3,5	

V	A	mm ² /AWG
250	24	0,5 ÷ 2,5
250	24	0,5 ÷ 2,5
300	14	30 ÷ 12

min 2 - max 24	
VE	
D/A1	

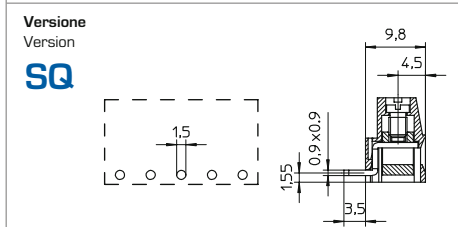
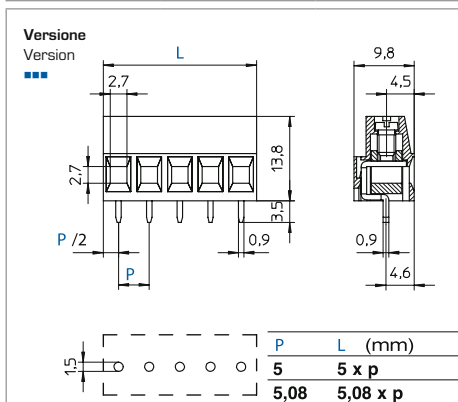

CLA

Blocco unico
Monobloc

Single block
Einzelblock



Poli
Póles

Poles
Polzahl

2/12

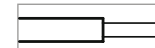
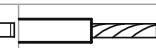
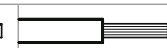

7,5	
500	
24	

		
0,2 ÷ 4 30 ÷ 12	0,2 ÷ 2,5 30 ÷ 12	0,2 ÷ 2,5 30 ÷ 12
6		
0,5	/	4
110		
PA - UL 94 V0		
M3		
	0,6 x 3,5	

V	A	mm ² /AWG
750	24	0,5 ÷ 2,5
750	24	0,5 ÷ 2,5
300	14	30 ÷ 12

min 2 - max 12	
VE	
D/A1	

